

# RCA

## Radiolas 21 and 22

SERVICE NOTES



RCA Radiola 21

First Edition—30M  
Copyright October, 1929

RADIO-VICTOR CORPORATION OF AMERICA  
233 BROADWAY, NEW YORK CITY

DISTRICT SERVICE STATIONS

BROOKLYN, N. Y.  
Bldg. No. 19—168-39th St.

CHICAGO, ILL.  
2001 West Pershing Road

SAN FRANCISCO, CAL.  
274 Brannan St.

DALLAS, TEXAS  
Santa Fe Bldg., Unit No. 2

ATLANTA, GA.  
150 Peters St.

## PREFACE

---

Service goes hand in hand with sales. The well-informed RCA Authorized Dealer renders service at time of sale in affording information as to proper installation and upkeep. Subsequent service and repair may be required by reason of wear and tear and mishandling, to the end that RCA Loudspeaker and Radiola owners may be entirely satisfied.

Obviously, this service can best be rendered by properly equipped service organizations having a thoroughly trained personnel with a knowledge of the design and operation of RCA Loudspeakers and Radiolas.

Such service organizations have been established by RCA Distributors, and RCA Authorized Dealers are advised to refer any major work or replacement to their selected Distributors. Minor replacements and mechanical and electrical adjustments may be undertaken by the RCA Dealer.

To assist in promoting this phase of the Dealer and Distributor's business the RCA Service Department has prepared a series of Service Notes—of which this booklet is a part—containing technical information and practical helps in servicing RCA Loudspeakers and Radiolas.

This information has been compiled from experience with RCA Dealers and Distributors' service problems and presents the best practice in dealing with them. A careful reading of these Service Notes will establish their value, and it is suggested they be preserved for ready reference.

In addition to supplying the Service Notes, the RCA Service Department maintains a corps of engineers who are qualified to render valuable help in solving service problems. These engineers call upon the trade at frequent intervals to advise and assist RCA Distributors in the performance of service work.

---

*Property of the Radio-victor Corporation of America. Confidential and to be used only by its Authorized Distributors and Dealers in furnishing service in connection with its apparatus*

---

*Copyright 1929—Radio-victor Corporation of America*

# CONTENTS

---

Préface .....		Page
Electrical and Physical Specifications .....		2
Introduction .....		5
		6

## PART I—INSTALLATION

Antenna (Indoor or Outdoor) .....	7	Shields .....	7
Ground .....	7	Batteries .....	7

## PART II—SERVICE DATA

Antenna System Failures .....	7	Adjusting R. F. Line-up Condensers .....	7
Radiotron Sockets and Prongs .....	7	Service Data on Reproducer Unit .....	7
Broken Condenser Drive Cord .....	7	Service Data Charts .....	8-9

## PART III—ELECTRICAL TESTS

Testing Condensers .....	10	Socket Voltages Radiola 21 or 22 .....	10
Voltage Readings .....	10	Radiola 21 or 22 Continuity Tests .....	11
		Continuity Test Charts .....	13-15

## PART IV—MAKING REPLACEMENTS

Removing Chassis from Cabinet of Radiola 21 .....	16	Removing Reproducer from Radiola 22 .....	16
Removing Receiver Assembly from Radiola 22 .....	16	Replacing R.F. Line-up Condensers .....	16

## ILLUSTRATIONS

RCA Radiola 21 .....	1	Schematic Circuit Diagram of Radiolas 21 and	
Rear Interior Cabinet View of Radiola 22 .....	4	22 Receivers .....	11
Top View of Receiver Chassis .....	5		
Sub-Chassis View of Receiver .....	6	Radiola 22 Battery Cable and External Con-	
Receiver View With Shields Removed .....	7	nections .....	12
Internal Connections of A.F. Coupling Unit .....	10	Wiring Diagram and Color Code .....	14

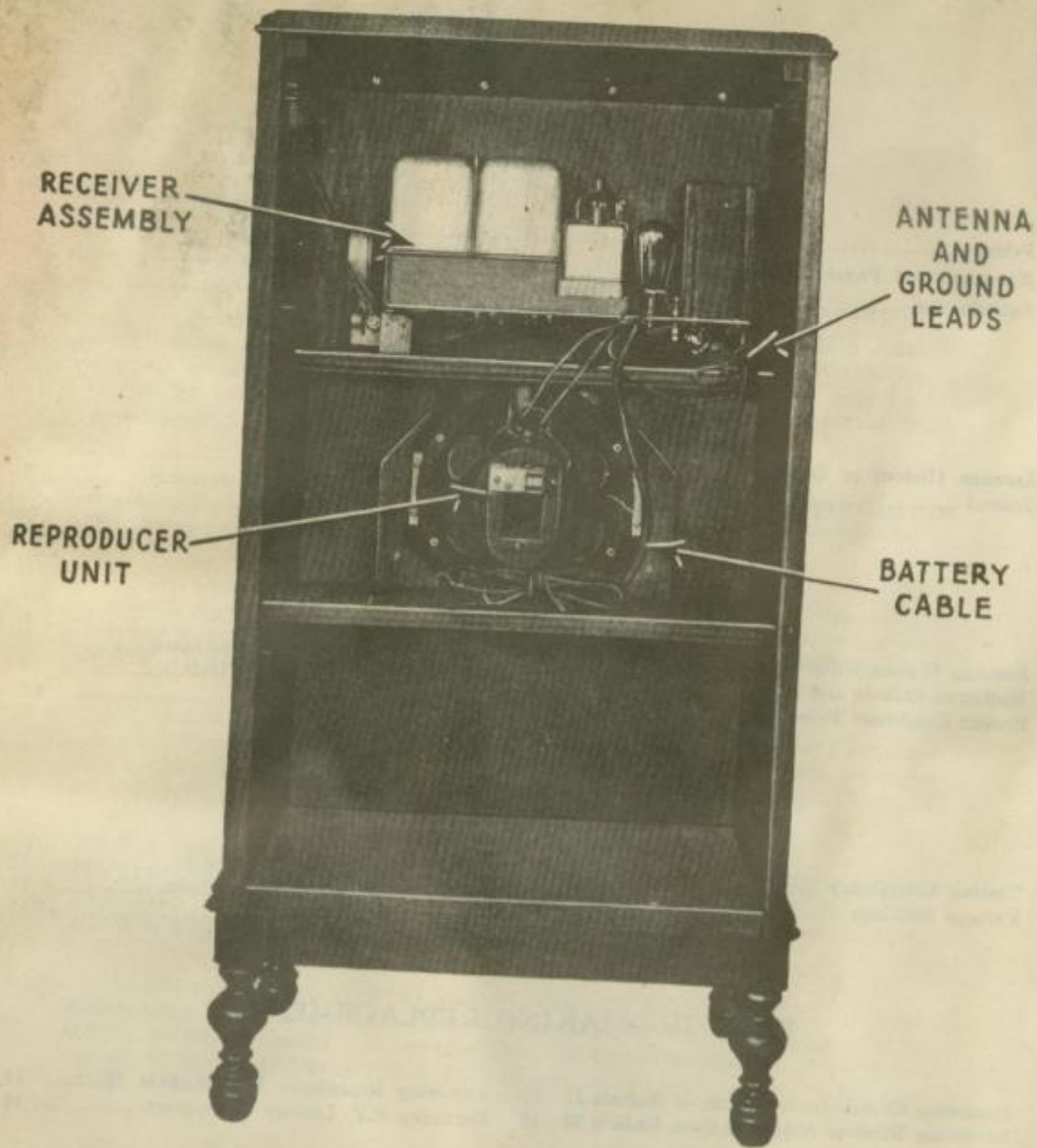

Figure 1—Rear interior cabinet view of Radiola 22

# RCA RADIOLAS 21 and 22

## SERVICE NOTES

Prepared by RCA Service Department

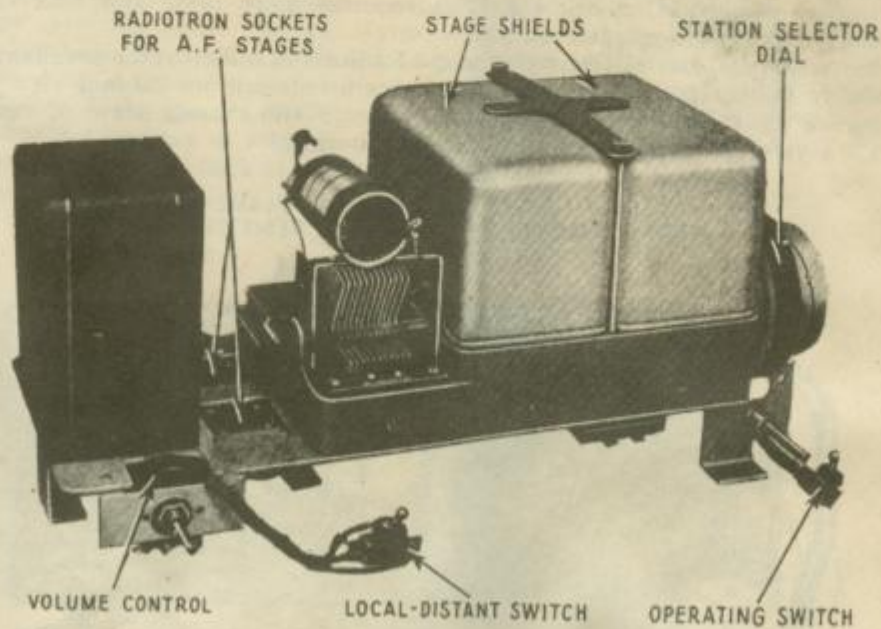

Figure 2—Top view of receiver chassis showing location of some parts

## ELECTRICAL AND PHYSICAL SPECIFICATIONS

- Type of Receiver—Screen Grid Tuned R.F. Battery.
- Recommended Antenna Length—25—60 feet.
- Type of Filament Power—Storage Battery or Eliminator.
- Type of Plate and Grid Power—"B" and "C" Batteries or Eliminator.
- Number and Type of Tubes—Two UX-222, 2 UX-112A, 1 UX-112A or UX-171A—Total 5.
- Number of R.F. Stages—Two.
- Type of Detector—Grid condenser and leak.
- Number of A.F. Stages—Two.
- Type of Loudspeaker (R22 only)—Magnetic.

	R21	R22
Height .....	10.5 inches	40.5 inches
Depth .....	10.0 "	22.0 "
Width .....	20.5 "	21.5 "
Weight, alone .....	27 lbs.	44 lbs.
Weight, packed .....	40 lbs.	105 lbs.

## INTRODUCTION

RCA Radiolas 21 and 22 are battery operated screen grid radio receiving sets. Radiola 21 is a table model and Radiola 22 is a console model employing the same receiver chassis and the mechanism of RCA Loudspeaker 100B. RCA Screen Grid Radiotrons UX-222 are employed as radio frequency amplifiers, Radiotrons UX-112A as the detector and first audio and UX-112A or UX-171A as the power stage. The choice of the power tube is left to the customer, as different tubes may be desirable for different output requirements. The different battery requirements may also have a bearing on the choice, as the UX-171A requires more plate and bias batteries to obtain advantage of its greater output.

The sensitivity and selectivity of these Radiolas is sufficient for excellent reception. The fidelity is very good. Figure 1 illustrates a rear interior cabinet view of Radiola 22, Figure 2 top view of receiver chassis, Figure 3 sub-chassis view of receiver, and Figure 4 a view of the receiver with shields removed.

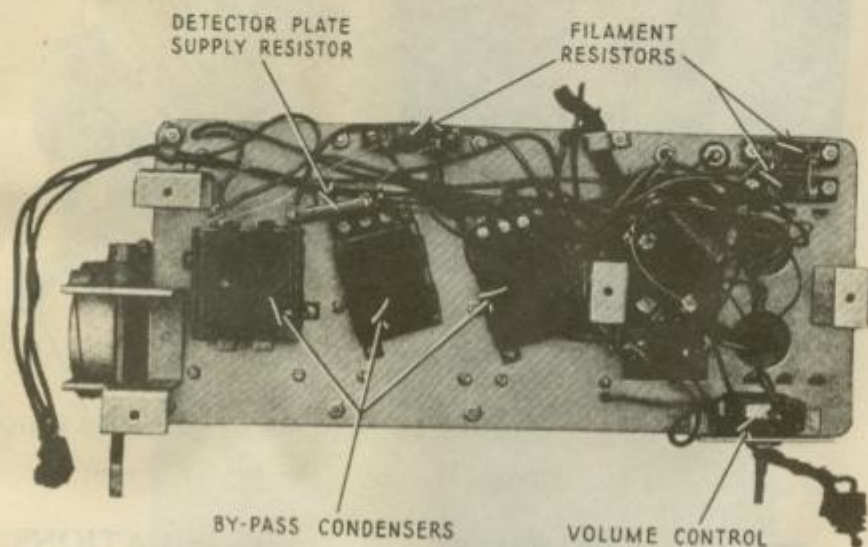

Figure 3—Sub-chassis view of receiver

Circuit features, see Figure 6, of these Radiolas are:

- (a) Screen grid battery receiver giving sensitivity and selectivity comparable to that obtained with A.C. type screen grid receivers.
- (b) Circuit consists of two tuned R.F. stages, tuned grid leak type detector, first audio stage and second audio stage employing a choice of power tubes.
- (c) Local-distant switch provides best reception on both loud and weak signals. At the local position a .00023 mfd. condenser is connected from the antenna connection to ground. This condenser or when the switch is at "distant," the antenna to ground capacity, causes the circuit to resonate in the broadcast band at about 700 K.C. and thereby brings up the sensitivity of the low frequency end. The result is that the receiver has about equal sensitivity throughout the tuning range.
- (d) The use of screen grid tubes together with proper shielding, eliminates the necessity of neutralizing or other methods of stabilizing.
- (e) The volume control varies the voltage on the screen grid of the two R.F. tubes. This provides a smooth means of control which, together with the local-distant switch, provides a positive cut-off even on loud local stations.

- (f) The operating switch disconnects the filament battery and the "B" voltage to the volume control. This prevents unnecessary "B" battery consumption when the receiver is not in use.
- (g) A fixed regenerative detector gives added sensitivity to that circuit with a resulting gain in over-all sensitivity. This does not require any adjustment during operation.

## PART I—INSTALLATION

Information on the various points dealing with installation as listed below can be obtained by referring to the Service Notes or Instruction Books mentioned. This information has been repeatedly published in past issues of Service Notes, and the average service man is probably so familiar with it, that further details are unnecessary.

*The Radiola 22 has two red wood screws to hold the reproducer unit during shipment. Be sure that these are removed as otherwise acoustic howling may result.*

Antenna (Indoor or outdoor).—See R-44 and 46 Service Notes.

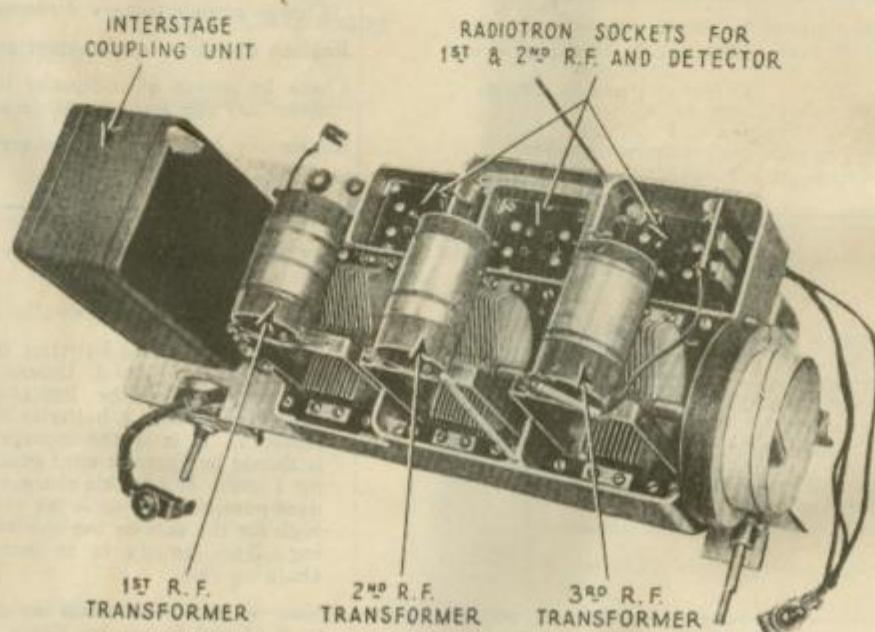

Figure 4—View of receiver with shields removed

Ground.—See R-44 and 46 Service Notes.

Shields.—See R-44 and 46 Service Notes.

Batteries and Connections.—See R-21 or 22 Instruction Book.

## PART II—SERVICE DATA

Service data on the following subjects can be obtained from the Service Notes mentioned below:

Antenna system failures.—See R-44 and 46 Service Notes.

Radiotron sockets and prongs.—See R-44 and 46 Service Notes.

Broken condenser drive cord.—See R-44 and 46 Service Notes.

Adjusting R.F. line-up condensers.—See R-44 and 46 Service Notes.

Service data on reproducer unit.—See R-100A or R-100B Service Notes.

## SERVICE DATA CHART

The following service data chart indicates various troubles by their symptoms and gives the specific remedy necessary.

<i>Indication</i>	<i>Cause</i>	<i>Remedy</i>
No Reproduction	Defective Radiotrons	Replace defective Radiotrons
	Defective Operating Switch	Replace defective operating switch
	Defective Volume Control	Replace defective volume control
	Wrong battery connections	Connect battery correctly. Complete instructions are given in R-21 or 22 Instruction Book
	Run-down batteries	Replace "B" and "C" batteries if low. Charge storage battery if necessary.
	Defective local-distant switch	Replace defective local-distant switch.
Low Volume	Defective parts in receiver	Check by means of continuity tests and make any replacement necessary
	Defective loudspeaker	Repair any defect in loudspeaker
	Defective Radiotrons	Test and replace any defective Radiotrons
	Poor antenna system	Install antenna as suggested in Part I
	Run-down batteries	Check voltage of all batteries including any eliminator if used. Unless the voltages are within the limits given in Part III, Section 2, batteries should be replaced. If it is the storage battery it should be charged until gassing lasts for 1 hour. If a trickle charger is being used possibly the rate is not sufficiently high for the service the receiver is giving. The remedy is to increase the charging rate.
	Line-up condensers out of adjustment	Adjust line-up condensers as described in R-44 and 46 Service Notes
Distorted Reproduction	Defective parts in receiver	Check by means of continuity test and make any replacement necessary
	Defective loudspeaker	Check by using another loudspeaker known to be in good operating condition and make any replacement necessary
	Defective Radiotrons	Test and replace any defective Radiotron
	Defective interstage A.F. transformer, output choke, output condenser or other parts	Check parts by means of continuity test and make any replacement necessary
	Receiver oscillation	Should the Radiolas oscillate, all signals will be weak, distorted and accompanied by a whistle. See section on "Oscillation" for remedies



## SERVICE DATA CHART—Continued

<i>Indication</i>	<i>Cause</i>	<i>Remedy</i>
Distorted Reproduction	Defective batteries	Check battery voltages and discard any with readings not in the limits given in Part III, Section 2, Charge storage battery if necessary
	Defective loudspeaker	Check with a loudspeaker known to be in good operating condition. Make any repairs necessary
Acoustic Howl	Radiotron selection	Interchange Radiotrons, especially the detector
	Loudspeaker mounting	Check mounting of loudspeaker of Radiola 22 and make sure it is properly supported
	Loudspeaker position	Do not place loudspeaker too close to Radiola 21. Increase its distance to the receiver or change the relative angle between the loudspeaker and the receiver
Audio Howl	An audio grunt or howl may be caused in Radiola 22 by reversed output leads to the loudspeaker	Connect loudspeaker leads as shown in Figure 7
	Oscillation	Receiver oscillation will cause a whistle when the receiver is tuned through a broadcasting station carrier wave. See section on "Oscillation" for remedies
	By-pass condenser	An open in any of the by-pass condensers may cause an audio howl
	Radiotrons	Vibrating elements in Radiotrons will cause a gradually developing howl. See section under "Acoustic Howl"
	Audio system	A defective audio system may cause a howl
Oscillation	Shields not in place or not making good contact	Place the tube shield over sockets 1 and 2 and the stage shields over sockets 2 and 3. If oscillation does not stop clean points of contact between base and all shields
	Local-distant switch not grounded	Ground local-distant switch properly
	Shield contact clips not clamping condenser shaft properly	Bend shield contact clips so that a good, firm contact is made to the condenser rotor shaft
	Open by-pass condenser	An open by-pass condenser or one improperly connected may cause oscillation. Check and replace if necessary
	Defective Radiotrons	A defective Radiotron UX-222 may cause oscillation. Interchanging with one known to be in good condition will remedy the trouble

## PART III—ELECTRICAL TESTS

### (1) TESTING CONDENSERS

Most of the condensers in Radiolas 21 and 22 can be tested by the continuity tests given in Part III, Section 3. If further tests are desirable the large 1 mfd. condensers may be tested by charging them with the highest "B" voltage available and then shorting their terminals with a screw-driver. An O.K. condenser will give a good spark when such a short is made. A leaky condenser will give no spark and a shorted condenser will give a spark when an attempt is made to charge it.

Small condensers may be click tested for shorts or conveniently replaced by new ones to check on their operating condition.

### (2) VOLTAGE READINGS

The following voltages taken at the sockets are correct for batteries when new. A 25 per cent drop is permissible before renewal is necessary. Individual batteries may be tested by disconnecting entirely and reading with a voltmeter. The "B" batteries should be discarded when their voltage is less than 34 volts per block. The "C" batteries should be renewed with the "B" batteries. A storage "A" battery requires charging when the voltage is below 5.4 for a battery or 1.8 per cell *under load*.

#### SOCKET VOLTAGES RADIOLA 21 OR 22

Radiotron UX-171A used in last stage with 135 volts plate supply. For other power tubes or plate voltage the change will be in last socket only, all other voltages remaining the same.

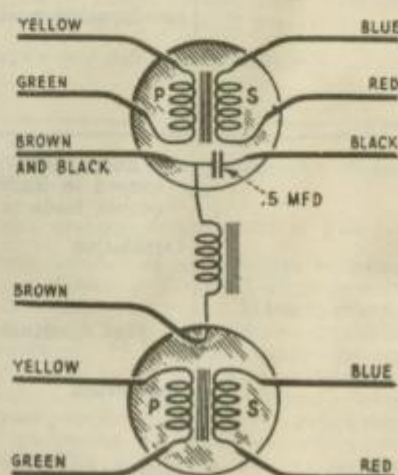

Figure 5—Internal connections of A.F. coupling unit

### VOLUME CONTROL AT MINIMUM

Socket No.	Filament Volts	Filament to Control Grid Volts	Filament to Screen Grid Volts	Filament to Plate—Volts	Plate Current Milliamperes
1	3.2	1.6	0	135	0
2	3.2	1.6	0	135	0
3	5.0	—	—	45	3.5
4	5.0	9	—	125	6.5
5	5.0	27	—	130	15



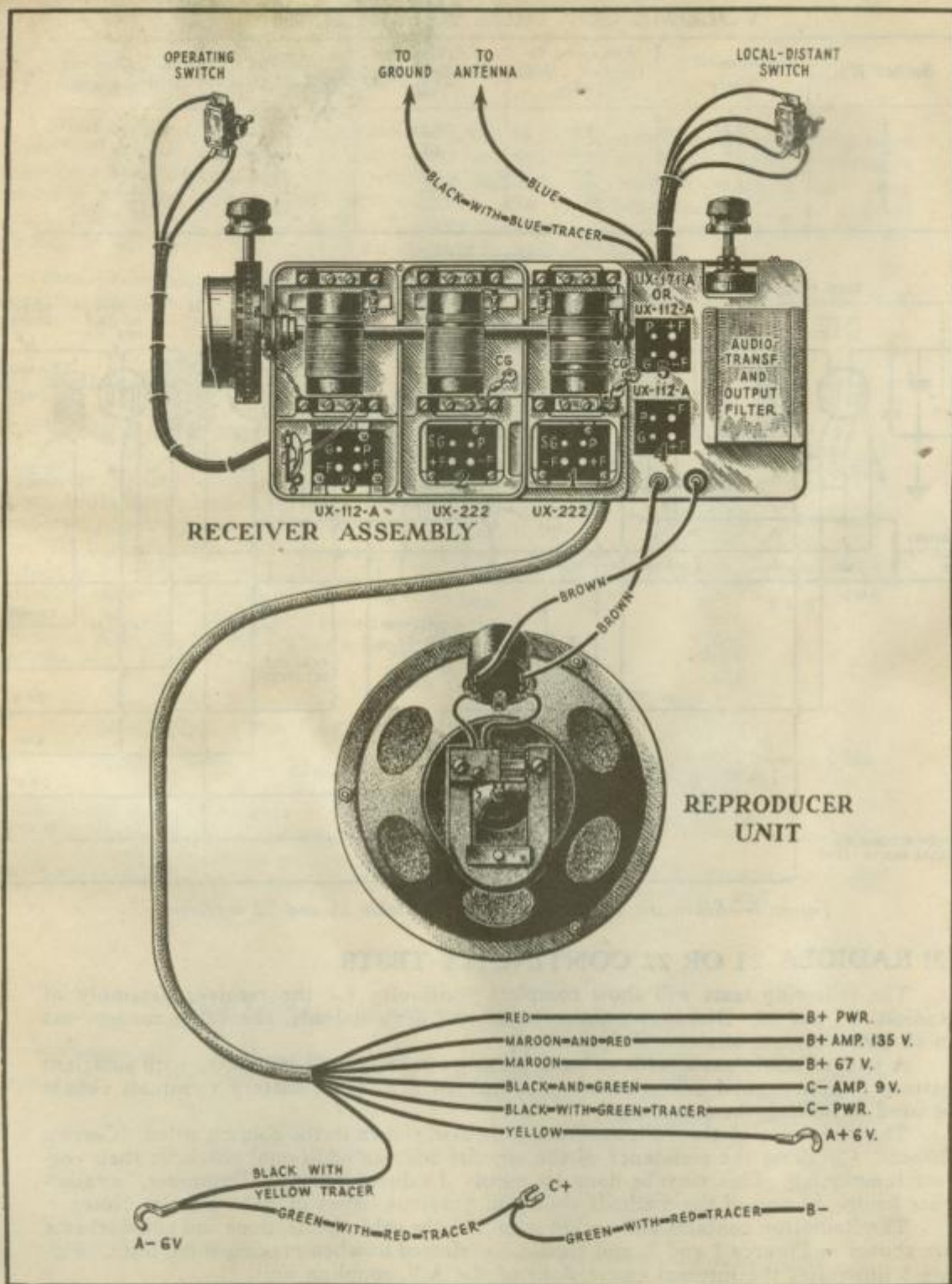

Figure 7—Radiola 22 battery cable and external connections of receiver assembly and reproducer unit

**CONTINUITY TEST CHART**  
**Unscrew Pilot Lamp Before Making Test**

Circuit	Test Terminals	Correct Effect	Incorrect Effect	
			Indication	Caused by
Grid	CG1 to Ground	Closed (3 Ohms)	Open Short	Open secondary of 1st R.F. transformer Shorted tuning or trimming condenser
	SG1 or SG2 to B+67 (Maroon) Vol. Cont. at minimum	Closed (50,000 Ohms)	Open	Open volume control or connection
	SG1 or SG2 to B+67 (Maroon) Vol. Cont. at maximum	Closed (Short)	Open	Open connection or volume control arm
	CG2 to Ground	Closed (3 Ohms)	Open Short	Open Secondary of 2nd R.F. transformer Shorted tuning or trimming condenser
	G3 to Ground	Closed (4 Megs)	Open 3 Ohms Short	Open grid leak or secondary of 3rd R.F. transformer Shorted grid condenser Shorted grid condenser and tuning or trimming condenser
	Stator tuning condenser No. 3 to Ground	Closed (3 Ohms)	Open Short	Open secondary of 3rd R.F. transformer Shorted tuning or trimming condenser
	G4 to C-9 (Black and Green)	Closed (5,500 Ohms)	Open	Open secondary of 1st A.F. transformer
	G5 to C-Pwr (Black with Green tracer)	Closed (5,500 Ohms)	Open	Open secondary of 2nd A.F. transformer
Plate	P1 to B+135 (Maroon and Red)	Closed (60 Ohms)	Open	Open primary of 2nd R.F. transformer
	P2 to B+135 (Maroon and Red)	Closed (60 Ohms)	Open	Open primary of 3rd R.F. transformer
	P3 to B+135 (Maroon and Red)	Closed (31,100 Ohms)	Open 1,100 Ohms	Open regenerative coil, primary of 1st A.F. transformer or 30,000 ohm resistor Shorted 30,000 ohm resistor
	P4 to B+135 (Maroon and Red)	Closed (1,000 Ohms)	Open	Open primary of 2nd A.F. transformer
	P5 to B+Pwr (Red)	Closed (550 Ohms)	Open	Open output choke
	P5 to output jack with insulating bushing	Open	Closed	Shorted .5 mfd. output condenser

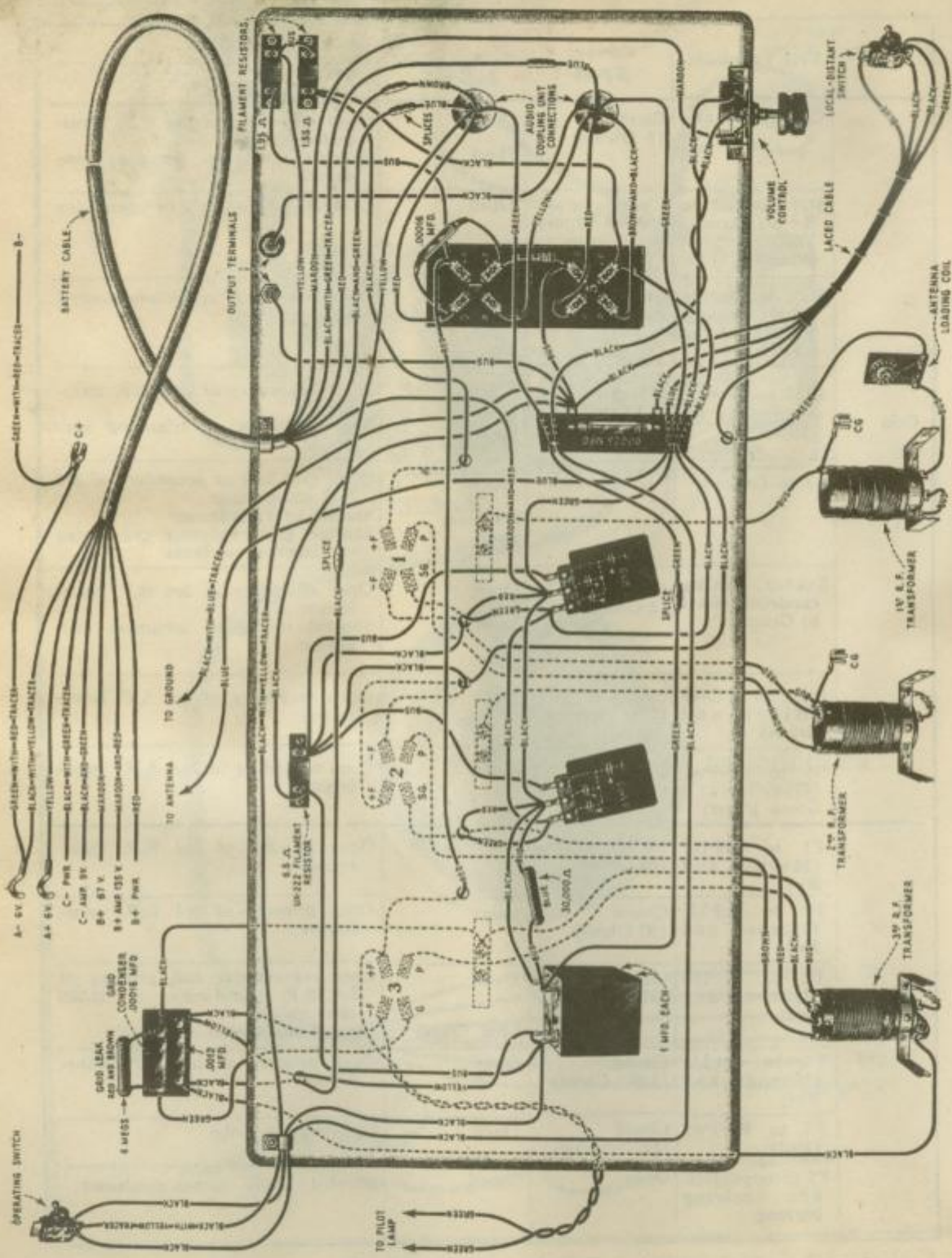

Figure 8—Wiring diagram showing color code and connections

## CONTINUITY TEST CHART—Continued

Unscrew Pilot Lamp Before Making Test

Circuit	Test Terminals	Correct Effect	Incorrect Effect	
			Indication	Caused By
Filament	—F1 to Ground	Closed (6.5 Ohms)	Open Short	Open UX-222 filament resistor or connection Shorted .1 mfd. condenser
	—F2 to Ground	Closed (6.5 Ohms)	Open Short	Open UX-222 filament resistor or connection Shorted .1 mfd. condenser
	—F3 to Ground	Closed (Short)	Open	Open connection
	—F4 to Ground	Closed (Short)	Open	Open connection
	—F5 to Ground	Closed (Short)	Open	Open connection
	+F1 to +A (Yellow)	Closed (1.55 Ohms)	Open	Open 1.55 ohm resistor or connection
	+F2 to +A (Yellow)	Closed (1.55 Ohms)	Open	Open 1.55 ohm resistor or connection
	+F3 to +A (Yellow)	Closed (1.95 Ohms)	Open	Open 1.95 ohm resistor or connection
	+F4 to +A (Yellow)	Closed (1.95 Ohms)	Open	Open 1.95 ohm resistor or connection
	+F5 to +A (Yellow)	Closed (1.55 Ohms)	Open	Open 1.55 ohm resistor or connection
Misc.	Antenna to ground (Switch at "distant" position)	Closed (30 Ohms)	Open	Open connection, antenna loading coil, or primary of first R.F. transformer
	B+67 (Maroon) to A—(Black with Yellow tracer) (Close op. sw.).	Closed (50,000 Ohms)	Open	Open volume control
	—F1 to B+135 (Maroon and Red)	Open	Closed	Shorted .1 mfd. condenser
	—F2 to B+ 135 (Maroon and Red)	Open	Closed	Shorted .1 mfd. condenser
	B+135 (Maroon and Red) to ground	Open	Closed	Shorted 1 mfd. condenser
	P3 to —F3	Open	Closed	Shorted 1 mfd. condenser or .0012 mfd. condenser
	G4 to —F4	Open	Closed	Shorted .00016 mfd. condenser
SG1 to —F1 SG2 to —F2	Open Open	Closed Closed	Shorted 0.1 mfd. condenser Shorted 0.1 mfd. condenser	

## PART IV—MAKING REPLACEMENTS

The various assemblies and parts of Radiolas 21 and 22 are readily accessible and replacements can be easily made. Figure 2 illustrates the receiver chassis and Figure 1 the rear interior cabinet view of Radiola 22. The following procedure gives the correct method for removing the various assemblies from their cabinets.

### (1) REMOVING CHASSIS FROM CABINET OF RADIOLA 21

To remove the receiver chassis from the cabinet of the Radiola 21, proceed as follows:

- (a) Release the local-distant switch and the operating switch from their respective escutcheon plates. This is best done by removing the wood screws that hold the escutcheon and then releasing the switch from the escutcheon by twisting its mechanism with the hand. This eliminates the possibility of marring the collar of the switches with pliers or other tools.
- (b) Remove the four machine screws at the bottom of the cabinet that holds the chassis in place.
- (c) Remove the volume control and station selector knobs from their respective shafts by merely pulling them off.
- (d) The chassis may now be lifted clear of the cabinet and placed in a position convenient for work.

### (2) REMOVING R-22 RECEIVER ASSEMBLY

To remove the receiver assembly of Radiola 22 proceed as follows:

- (a) Release the operating switch and local distant switch by removing their escutcheons and releasing the switch collar. Replace the escutcheons temporarily.
- (b) Remove the station selector and volume control knobs.
- (c) Release the antenna and ground leads and the battery cable. Remove the loudspeaker connections from the pin jacks on the receiver assembly.
- (d) Remove the four machine screws that hold the chassis to the shelf. It may now be lifted clear and placed in a position convenient for work. After the completion of all repairing replace it in the reverse manner of that used to remove it.

### (3) REMOVING R-22 REPRODUCER UNIT

To remove the R-22 reproducer unit proceed as follows:

- (a) Release the two loudspeaker leads from the receiver chassis at the output pin jacks.
- (b) Remove the eight screws that hold the reproducer unit mounting felt to the baffle board. The unit together with its felt mounting may be lifted clear and placed in a position convenient for work. After all work is completed it should be replaced in the reverse manner of that used to remove it.

### (4) REPLACING R.F. LINE-UP CONDENSERS

The correct procedure for replacing the R.F. line-up condensers is given in the Radiola 44 and 46 Service Notes and should be followed when making a replacement of this kind.



**Changes Necessary**

*for*

**Adapting Radiolas**

**21 or 22**

*for use with*

**Radiotrons RCA-230**

**RCA-231 and RCA-232**



**Radiola Division**

**RCA Victor Company, Inc.**

**Camden, N. J., U. S. A.**



## Changes Necessary for Adapting Radiolas 21 or 22 for use with Radiotrons RCA-230, RCA-231 and RCA-232

---

1. Remove receiver assembly from cabinet, place in a position convenient for work and turn upside down. Make the following changes. Figure 1 shows the wiring after the changes have been made, the dotted heavy lines indicating the old connections. Figure 2 shows the schematic diagram of the Radiola after changes have been made.
2. Remove bus from  $-F4$  to  $+F5$ .
3. Shift bus bar connected to  $+F5$  from  $+F5$  to  $-F4$ . The other end of this bus connects to the .00023 mfd. condenser.
4. Solder yellow cable lead formerly connected to 1.95 ohm resistor to  $+F5$ .
5. Shift the two black leads connected from  $-F1$  and  $-F2$  to the 6.5 ohm resistor from the 6.5 ohm resistor to  $+F4$ . It will be necessary to splice and tape a wire to these leads in order to make this change.
6. Clip the bus between the 1.95 and the 1.55 ohm resistor.
7. Shift all connections to the 6.5 ohm resistor to one terminal. This should be the terminal closest to socket No. 1.
8. Unsolder both connections to the pilot lamp. Clip these off at socket No. 3 and tape up the exposed ends. Solder two new thin leads to the pilot lamp connecting one to the terminal on the 6.5 ohm resistor to which no connections are present. Connect the other to  $+F5$ . It is best to run these leads through the hole in the bottom of the chassis into the detector stage and thence out of the side of the casting to the pilot lamp.
9. Remove the maroon and red cable lead from the center terminal of the third (closest to socket No. 1) by-pass condenser block. Also remove the green A. F. transformer lead from the same point. Unsolder the 30,000 ohm resistor from the center connection of the second by-pass condenser block, solder on about a three-inch length of wire, and then solder the other end of this wire to the maroon and red cable lead and the green transformer lead already exposed. Tape both joints carefully.

10. Connect about a three-inch length of wire to the center connection of the third by-pass condenser block. (Where the maroon and red cable lead was formerly connected.) The other end of this wire is connected to the splice between the red cable lead and the brown output choke lead. Tape carefully after soldering.
11. Solder a 400 ohm, 1 watt resistor from —F5 to the ground side of the .00023 mfd. condenser.
12. Substitute new cable tag supplied for old one.

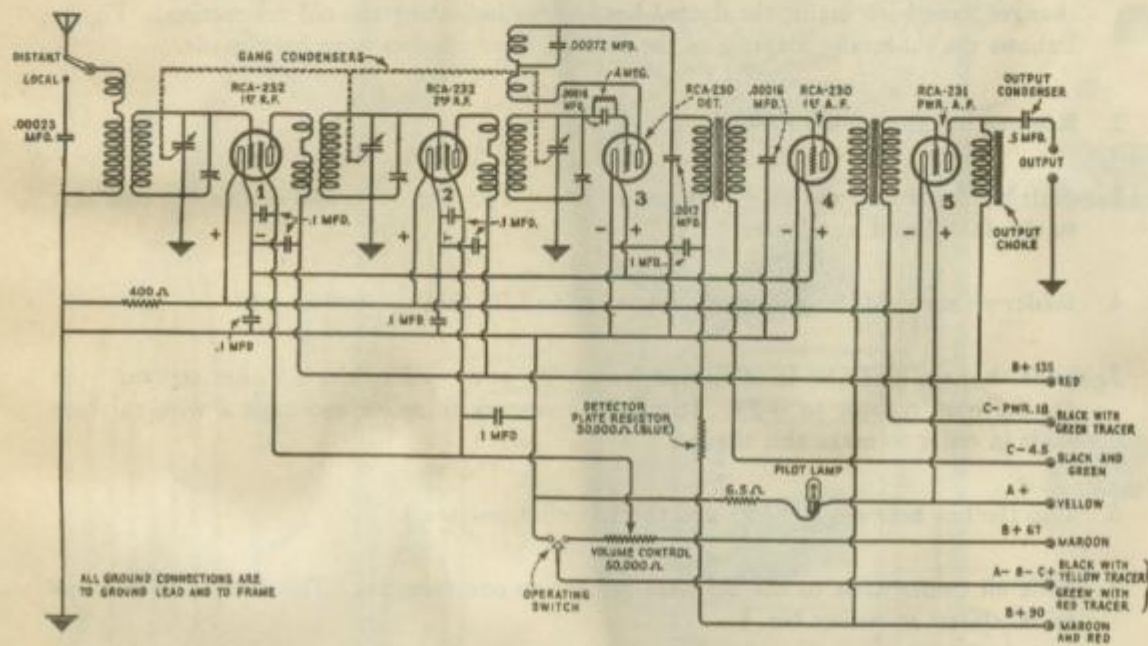

Figure 2

13. Paste new license notice over old one in cabinet.
14. Remove instruction book and guarantee card in envelope and substitute new card furnished. Destroy guarantee card as guarantee is printed on license label.
15. Place new Radiotrons in sockets as indicated on new instruction card, connect batteries in accordance with new battery tag and test Radiola.
16. Return chassis to cabinet in reverse manner of that used to remove it and return to shipping carton.